

BXS3 Secondary Cleaner

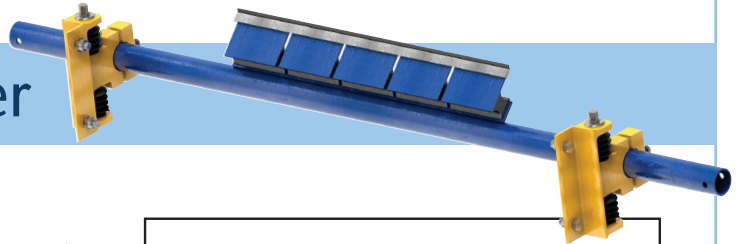

Features & Benefits

- **Compact design**- can be installed and maintained in most chute applications
- **Individual self adjusting galvanized mild steel bases**- each tensioned to the belt by impact absorbing cushions ensuring optimal cleaning
- **Replaceable abrasion resistant, tungsten carbide or ceramic cartridges**- durable and easy to maintain
- **Sits close to pulley** –ensures the material fines are directed back into the regular material flow
- **Positioned at laid back blade angle**- allows mechanical splices to pass without any damage

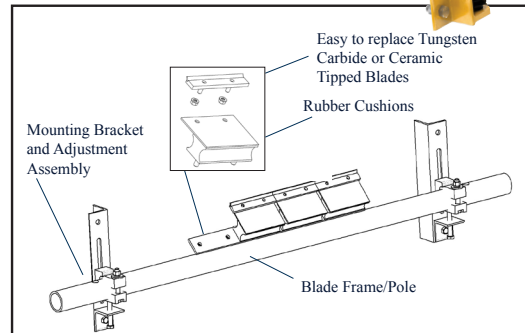

The BXS3 cleaner consists of individual 150 mm segmented blades, each one mounted to a durable rubber cushion. Separate blades ensure constant blade to belt contact on uneven surfaces, guaranteeing maximum cleaning performance.

Ordering Information

Belt Width		Blade Qty	Tungsten Carbide Ordering Number	Ceramic Ordering Number
in	mm			
18	457	3	BXS3-018-1T11X	BXS3-018-1C11X
24	610	4	BXS3-024-1T11X	BXS3-024-1C11X
30	762	5	BXS3-030-1T11X	BXS3-030-1C11X
36	914	6	BXS3-036-1T11X	BXS3-036-1C11X
42	1067	7	BXS3-042-1T12X	BXS3-042-1C12X
48	1219	8	BXS3-048-1T12X	BXS3-048-1C12X
54	1372	9	BXS3-054-1T13X	BXS3-054-1C13X
60	1524	10	BXS3-060-1T13X	BXS3-060-1C13X
72	1829	12	BXS3-072-1T13X	BXS3-072-1C13X
84	2134	14	BXS3-084-1T13X	BXS3-084-1C13X
96	2438	16	BXS3-096-1T13X	BXS3-096-1C13X
Replacement Cartridges			BXS3T-S	BXS3B-C

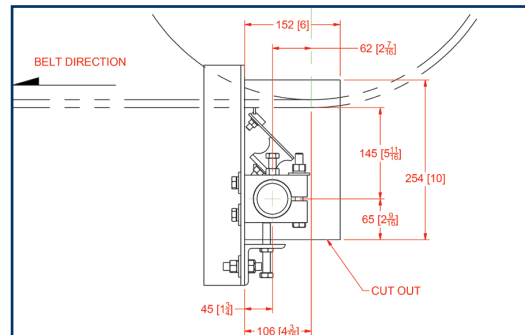

Optimally positioned off the head pulley in a trailing position, the passive position allows imperfections to pass through the cleaner. The angled tips contact the belt at 90 degrees ensuring maximum cleaning performance.

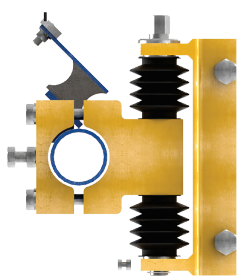

Full Assembly



Tungsten Carbide
Blade with Base

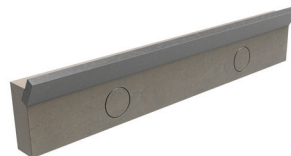

Tungsten Blade



Ceramic Blade